

SLIM HOOD

EFCH 6101 HM SS
EFCH 9101 HM SS



THE BEAUTY OF SIMPLICITY



USER MANUAL

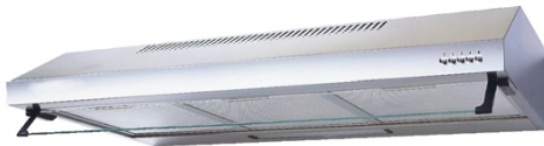

Table of Contents

• From the Manufacturer	3
• Specifications	3
• SAFETY: Read this before installation	4
• Description of Parts	5
• Operation Mode	6
• Installation	8,9
• Operation	10
• Cleaning & Maintenance	10
• Troubleshooting	11

- **From the Manufacturer**

- This appliance and the packaging are produced by processes that minimize waste and respect the environment.
- Please help us to continue the protection of the environment by disposing the packaging in a correct way.
- **Safety!**
- Please do not allow young children to play with the plastic bag packaging.
- Before disposing of any old appliances, be sure to cut off the power cord so that others will not be endangered by a defective electric appliance.

Specifications

Input: 220-240V 50Hz

Power

2 motor version: 2×85W

Lamp: 2x40W

Dimensions

60cm version: W600xD495xH140mm

90cm version: W900xD495xH140mm

SAFETY: Read this before installation

- Do not connect the appliance if there are obvious signs of transportation damage.
- Read this user manual thoroughly before attempting to use this appliance
- Installation and repair should be attempted only by qualified technical personnel.
- It is dangerous to modify any part of this appliance.
- The manufacturer declines all responsibility in case of failure to adopt proper safety measures.
- Ensure the location in which this appliance is installed has good, permanent ventilation.
- The distance between the bench top to the lower part of the hood must not be less than 65cm or higher than 75cm.
- Check that the voltage in your area is correct before plugging in.
- The electrical connection of this appliance must be connected to earth.

Green & yellow	=	EARTH
Blue	=	NEUTRAL
Brown	=	LIVE
- Multiple plugs and extension cables must not be used. Overload is dangerous and may cause a fire.
- Ensure that the power supply cord is free from any heat source or sharp objects.
- The appliance should be switched off and the electrical supply disconnected before any cleaning or maintenance work can be carried out.

Description of Parts

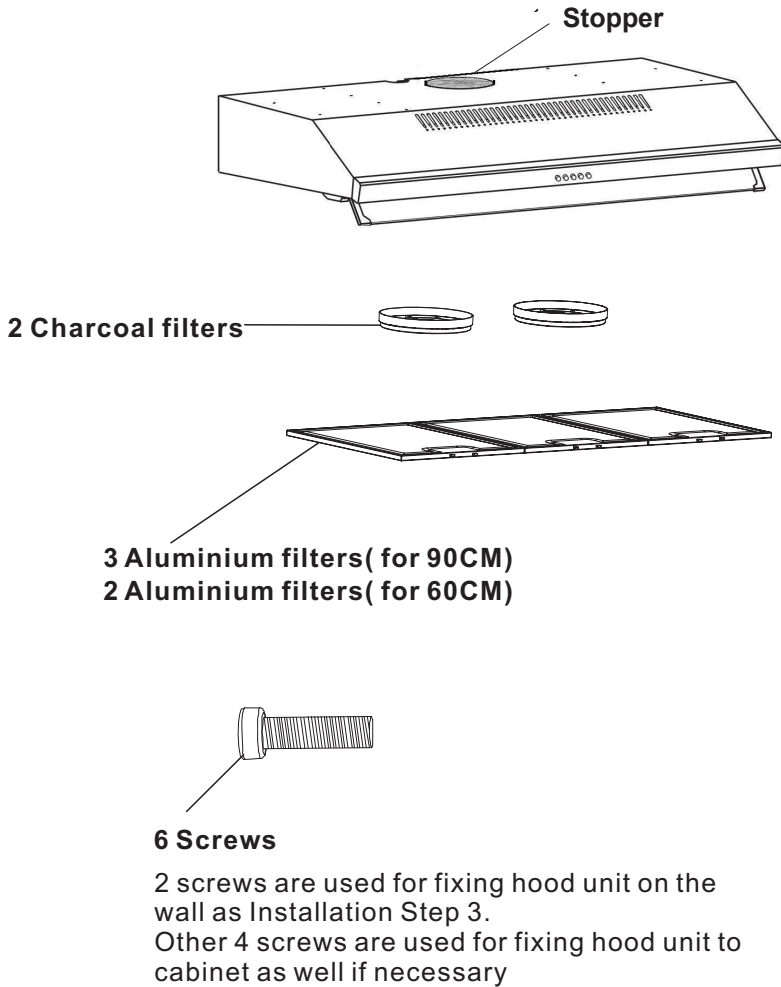

Operation Mode

This appliance can be configured to operate in ducted mode or re-circulation mode:

A. RE-CIRCULATION MODE

This appliance is pre-configured with re-circulation mode. In re-circulation mode, fumes are filtered for grease and odour through the aluminium grease filters and the charcoal filters respectively and re-introduced into the kitchen environment.

Both the aluminium grease filters and the charcoal filters must be installed.

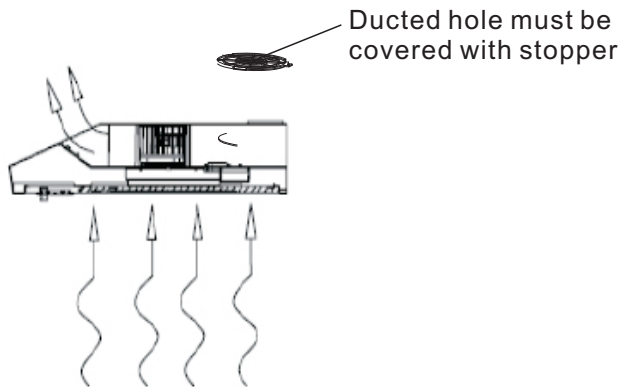

B. DUCTED MODE (VENTED MODE)

In ducted mode, cooking fumes are vented outdoors through suitable connection of 125mm diameter. In this mode, only the aluminium filters are installed.

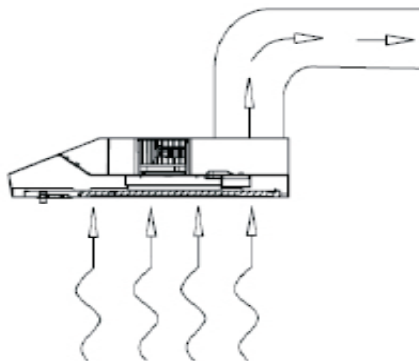

To change the operation to ducted mode, please follow the following steps:

- Remove aluminium grease filters
- Locate the 2 setting screws

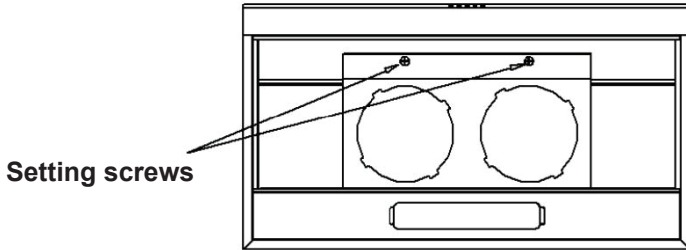

- Turn the setting screws clockwise until it is fully tightened. The front ventilation will be covered by a plate.
- Unscrew the stopper located at the top of the cooker hood.

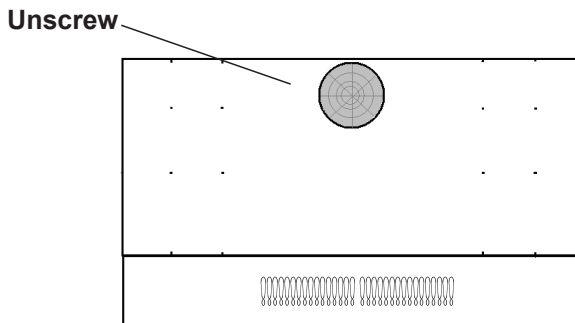

- Install the outlet connector (125mm) (connector and flexible hose not supplied).
- Remove the charcoal filters (not required for ducted mode).

Installation

STEP 1: Remove the aluminium filters and place them in a safe location to avoid damage.

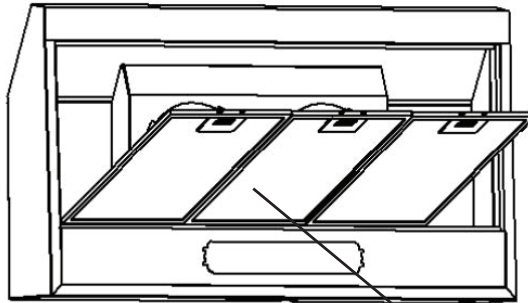

Remove the filters

STEP 2: Fix the 2 screws on the wall (follow the required length as stated below).
Do not fully tighten the screws.

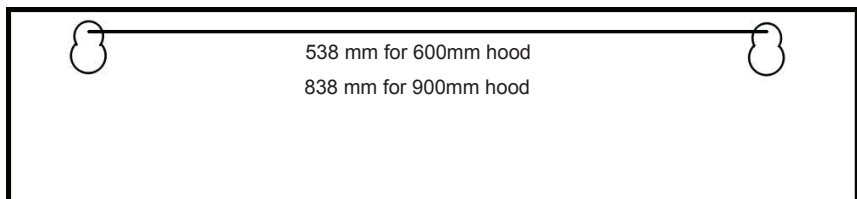

Installation

STEP 3: Hang the hood and then fully tighten the 2 screws in clockwise direction.

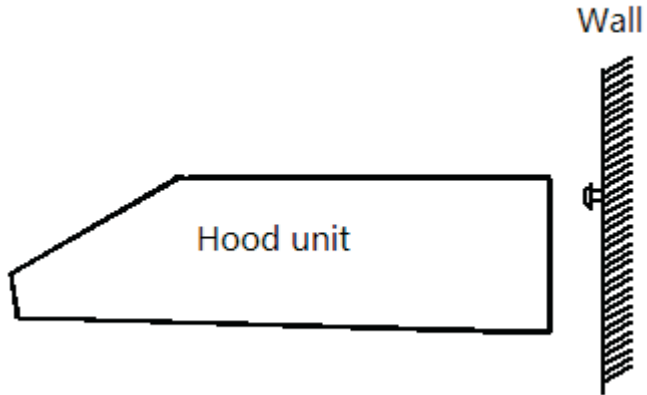

STEP 4: Connect the hood to power socket (13 Amp)

STEP 5: Remove the plastic packing for charcoal filters (for re-circulation mode).





STEP 6: Put back the aluminium filters.

Operation

The hood is equipped with 3 speed control.

Use the low speed for simmering, medium speed for light cooking. Use the high speed for frying or heavy cooking.

It is also equipped with a lamp to illuminate your cooking area when needed.

-  turns off switch
-  low speed setting
-  medium speed setting
-  high speed setting
-  light switch

Cleaning & Maintenance

SURFACES: Wash with warm soapy water and a soft sponge. Never use abrasive detergent, scouring pads, steel wool or solvents on any part of this appliance as this will cause irreparable damage.

ALUMINIUM GREASE FILTERS: Wash in the dishwashers or soak the panels in a degreasing agent for an hour, then rinse off.

CHARCOAL FILTERS (only for re-circulating mode): Charcoal filter cannot be reused. They must be replaced once a year or depending on the frequency of the appliance usage.

For this appliance to function effectively, regular maintenance is a must. Clogged filters restrict airflow and may cause the motor to overheat.

Troubleshoot

Symptoms	Possible Cause	Action
Not functioning	No electrical supply	Check that the plug is connected
		Check that the main switch is turned on
Poor airflow	Aluminium grease filters clogged	Clean the filters and replace when dry
	Charcoal grease filters clogged	Replace charcoal filters with new sets
Motor running but no airflow	Butterfly valve jammed	Contact Customer Service
Motor cut off after a few minutes	High temperature safety device activated	The kitchen is not sufficiently ventilated
	The hood is installed too near to the cooking stove	The hood must be at least 65cm from stove
Strong cooking smell	Charcoal filters not installed	In re-circulating mode, charcoal filters must be installed
	Charcoal grease filters clogged	Replace charcoal filters with new sets
Oil dripping onto stove	Aluminium grease filter saturated	Wash the aluminium grease filters
Whirring sound	Foreign object in contact with fan blade	Contact Customer Service

For original parts & reliable service

CASA (S) PTE LTD
15 KIAN TECK CRESCENT
SINGAPORE 628884
TEL: +65 6268 0077
FAX: +65 6898 0510
EMAIL: service@casa.com.sg