



NATURAL CONVECTION OVENS



Instruction for the use - Installation advice
KEEP IN A SAFE PLACE

Before operating this oven,
please read these instructions carefully

Dear Customer,

Thank you for having purchased and given your preference to our product.

The safety precautions and recommendations within this booklet are for your own safety and that of others. They will also provide a means by which to make full use of the features offered by your appliance.

Please preserve this booklet carefully. It may be useful in future, either to yourself or to others in the event that doubts should arise relating to its operation.

This appliance must be used only for the task it has explicitly been designed for, that is for cooking foodstuffs. Any other form of usage is to be considered as inappropriate and therefore dangerous.

The manufacturer declines all responsibility in the event of damage caused by improper, incorrect or illogical use of the appliance.

DECLARATION OF CE CONFORMITY

- This oven has been designed to be used only for cooking. Any other use (such as heating a room) is improper and dangerous.
- This oven has been designed, constructed, and marketed in compliance with:
 - safety requirements of EEC Directive "Low voltage" 73/23
 - safety requirements of EEC Directive "EMC" 89/336;
 - requirements of EEC Directive 93/68.



IMPORTANT INFORMATION FOR CORRECT DISPOSAL OF THE PRODUCT IN ACCORDANCE WITH EC DIRECTIVE 2002/96/EC.

At the end of its working life, the product must not be disposed of as urban waste. It must be taken to a special local authority differentiated waste collection centre or to a dealer providing this service.

Disposing of a household appliance separately avoids possible negative consequences for the environment and health deriving from inappropriate disposal and enables the constituent materials to be recovered to obtain significant savings in energy and resources. As a reminder of the need to dispose of household appliances separately, the product is marked with a crossed-out wheeled dustbin.

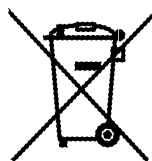

IMPORTANT PRECAUTIONS AND RECOMMENDATIONS

- After having unpacked the appliance, check to ensure that it is not damaged. If you have any doubts, do not use it and contact the store from where you purchased it.
- Packing materials (i.e. plastic bags, polystyrene foam, nails, packing straps, etc.) should not be left around within easy reach of children, as these may cause serious injuries.
- Do not attempt to modify the technical characteristics of the appliance as it may become dangerous to use.
- Do not carry out cleaning or maintenance operations on the appliance without having previously disconnected it from the electric power supply.
- If you should decide not to use this appliance any longer (or decide to substitute an older model), before disposing of it, it is recommended that it be made inoperative in an appropriate manner in accordance to health and environmental protection regulations, ensuring in particular that all potentially hazardous parts be made harmless, especially in relation to children who could play with old appliances.

IMPORTANT PRECAUTIONS AND RECOMMENDATIONS FOR USE OF ELECTRICAL APPLIANCES

Use of any electrical appliance implies the necessity to follow a series of fundamental rules. In particular:

- Never touch the appliance with wet hands or feet;
- do not operate the appliance barefooted;
- do not allow children or disabled people to use the appliance without your supervision.

The manufacturer cannot be held responsible for any damages caused by improper, incorrect or unreasonable use of the appliance.

USING THE OVEN FOR THE FIRST TIME

You are advised to carry out the following operations:

- Assemble the interior of the oven as described under the heading “Cleaning and maintenance”
- Switch the empty oven ON at maximum temperature for about two hours to eliminate traces of grease and smell from the components.
- Let the oven cool down, switch off the electrical supply, then clean the inside of the oven with a cloth soaked in water and neutral detergent and dry thoroughly.

Control panel

1

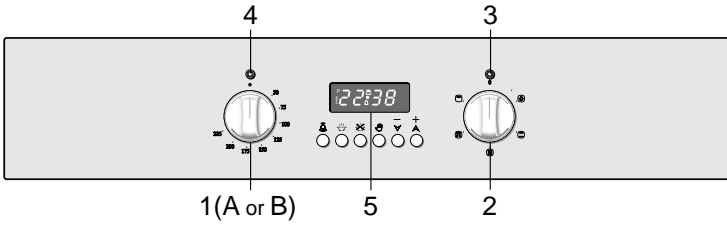

Fig. 1.1

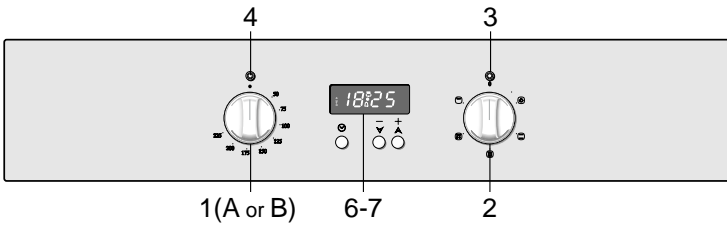

Fig. 1.2

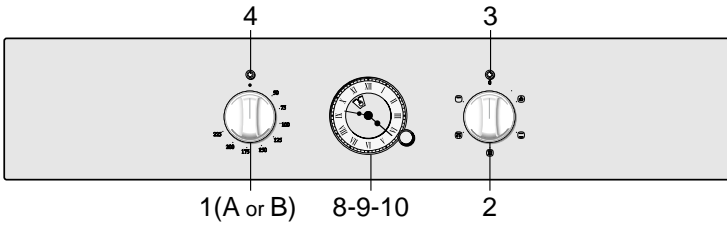

Fig. 1.3

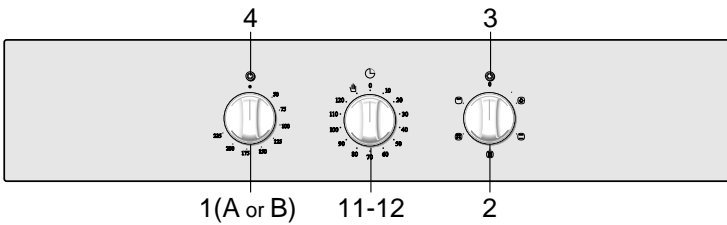
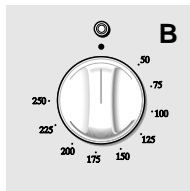
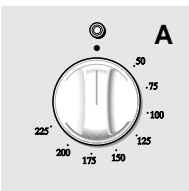

Fig. 1.4



TYPES OF THERMOSTAT

Depending on the models the thermostat could be of type A (50 to 225°C) or type B (50 to 250°C)

Fig. 1.5

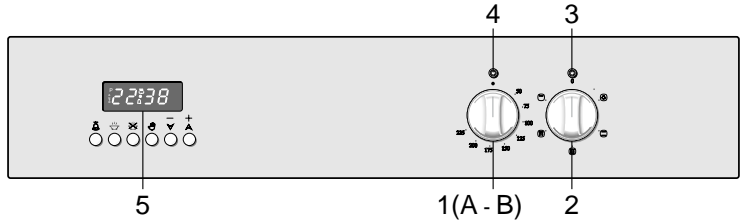

Fig. 1.6

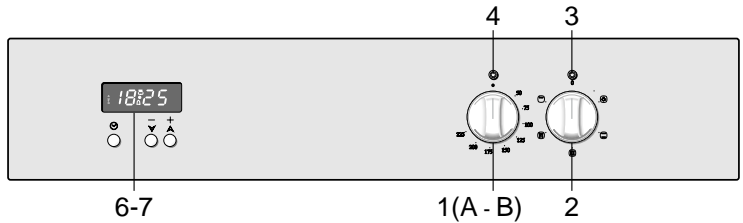

Fig. 1.7

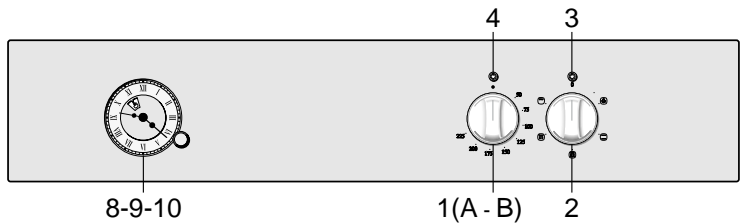
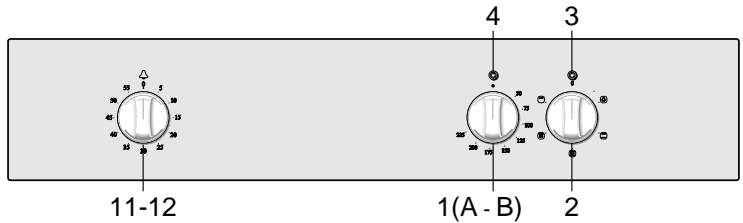

Fig. 1.8



CONTROL PANEL

- | | |
|---------------------------------------|---------------------------------|
| 1. Oven thermostat knob (type A or B) | 7. Electronic clock |
| 2. Function selector knob | 8. Clock programmer (start-end) |
| 3. Power on indicator lamp | 9. Electric clock with alarm |
| 4. Oven temperature indicator lamp | 10. Electric clock |
| 5. Electronic programmer | 11. Timer (120' cut-off) |
| 6. Electronic clock/end cooking timer | 12. 60' alarm |

GENERAL FEATURES



As its name indicates, this is an oven that presents particular features from an operational point of view.

In fact, it is possible to insert 4 different programs to satisfy every cooking need.

The 4 positions, thermostatically controlled, are obtained by 3 heating elements which are:

- Lower element 1300 W
- Upper element 1000 W
- Grill element 2000 W

Note:

When using for the first time, you are advised to run the oven at maximum temperature ((thermostat knob on the maximum position) for approximately one hour in the  mode and for another 15 minutes in the  mode in order to eliminate any traces of grease from the electrical elements.

WARNING:

The door is hot, use the handle.

During use the appliance becomes hot. Care should be taken to avoid touching heating elements inside the oven.

Attention: the oven door becomes very hot during operation. Keep children away.

OPERATING PRINCIPLES

Heating and cooking in the conventional oven are obtained:

a. by natural convection

The heat is produced by the upper and lower heating elements.

b. by radiation

The heat is radiated by the infra red grill element (**use with the oven door closed.**).

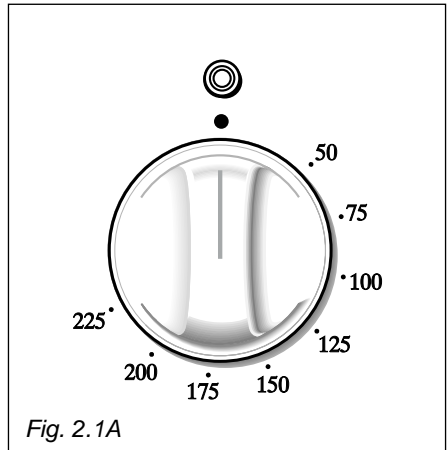

THERMOSTAT KNOB (fig. 2.1A - 2.1B)

To turn on the heating elements of the oven, set function selector knob to the required position and the thermostat knob to the desired temperature.

To set the temperature, turn the thermostat control knob indicator mark to the required temperature.

The elements will turn on or off automatically which is determined by the thermostat.

The operation of the heating elements is signalled by a light placed on the control panel.

FUNCTION SELECTOR KNOB (fig. 2.2)

Rotate the knob clockwise to set the oven to one of the following functions:



OVEN LIGHT

By turning the function selector knob to this setting, the oven light will illuminate in the oven cavity (15W).

The oven light will operate on all selected functions.



TRADITIONAL CONVECTION COOKING

The upper and lower heating elements come on.

The heat is diffused by natural convection and the temperature must be regulated between 50°C and the maximum position with the thermostat knob.

It is necessary to preheat the oven before introducing the foods to be cooked.

In the  position the rotisserie motor come on for cooking with the rotisserie.

Recommended for:

For foods which require the same cooking temperature both internally and externally, i. e. roasts, spare ribs, meringue, etc.

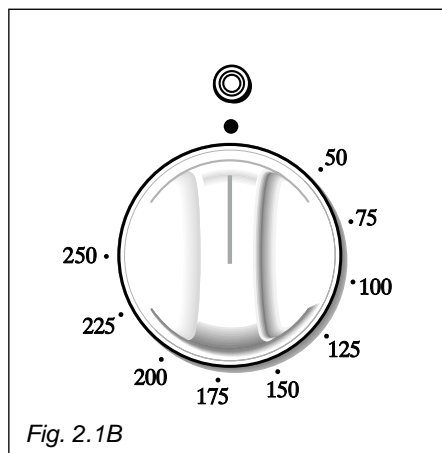

Fig. 2.1B

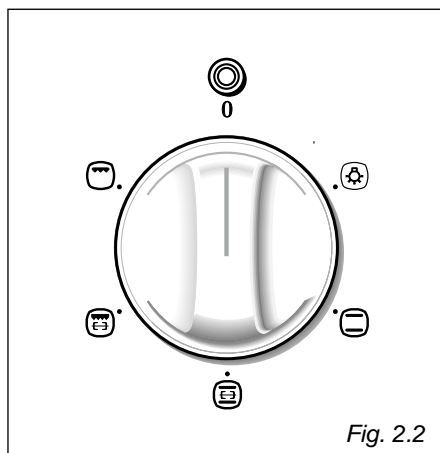



Fig. 2.2



TRADITIONAL GRILLING

The infra-red heating element is switched on. The heat is diffused by radiation.

Use with the oven door **closed** and the thermostat knob must be regulated between 50°C and 200°C max.

In the  position the rotisserie motor come on for cooking with the rotisserie.

For correct use see chapter “USE OF THE GRILL”.

Recommended for:

Intense grilling action for cooking with the broiler; browning, crisping, “au gratin”, toasting, etc.

It is recommended that you do not grill for longer than 30 minutes at any one time.

Attention: the oven door becomes very hot during operation. Keep children away.

USE OF THE GRILL

Leave to warm up for approximately 5 minutes with the door **closed**.

Place the food inside positioning the rack as near as possible to the grill.

Insert the drip pan under the rack to collect the cooking juices.

Grilling with the oven door closed and do not for longer than 30 minutes at any one time.



Attention: the oven door becomes very hot during operation. Keep children away.

ROTISSERIE (Fig. 2.3)

The oven is equipped with a rotisserie.



This device is made up of:

- an electrical motor mounted on the rear part of the oven
- stainless steel spit with a removable stay-cool handle and two adjustable sets of prongs
- spit support to be inserted in the central guide of the oven.

The rotisserie motor is operated by the switch knob on position  or .

Attention: the oven door becomes very hot during operation. Keep children away.

USE OF THE ROTISSERIE (Fig. 2.3)

- Insert the tray into the lowest rack holders of the oven and insert the rod support into the intermediate rack holders.
- Put the meat to be cooked onto the rod, being careful to secure it in the center with the special forks.
- Insert the rod into the motor opening and rest it onto the support of the spit collar; then remove the grip by turning it to the left.
- Close the oven door and switch on the turnspit (switch knob on position  or ).

The rotation direction of the rotisserie can be either clockwise or counter-clockwise.

Very important: the rotisserie must always be used with the oven door closed.

Attention: the oven door becomes very hot during operation.

Keep children away.

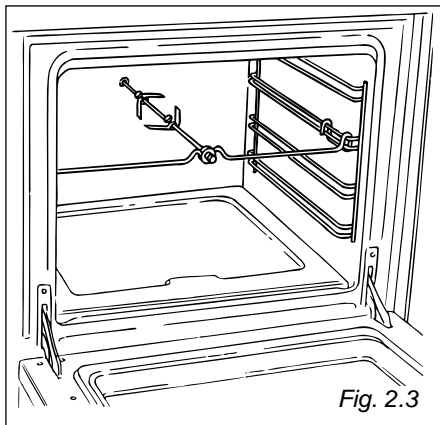









Fig. 2.3

The electronic programmer is a device which groups together the following functions:

- 24 hours clock with illuminated display
- Timer (up to 23 hours and 59 minutes)
- Program for automatic oven cooking
- Program for semi-automatic oven cooking

Description of the buttons:

-  Timer
-  Cooking time
-  End of cooking time
-  Manual position and cancellation of the inserted cooking program
-  or  To increase the numbers on the digital display
-  or  To decrease the numbers on the digital display.

Description of the illuminated symbols:

AUTO - *flashing* - Programmer in automatic position but not programmed

AUTO - *illuminated* - Programmer in automatic position with program inserted.





 Automatic cooking taking place

 Timer in operation

 and **AUTO** - *flashing* - Program error.

(The time of day lies between the calculated cooking start and end time).

Note:

Select a function by the respective button and, in 5 seconds, set the required time with the  () /  () buttons ("one-hand" operation).

After a power cut the display resets to zero and cancels the set programs.

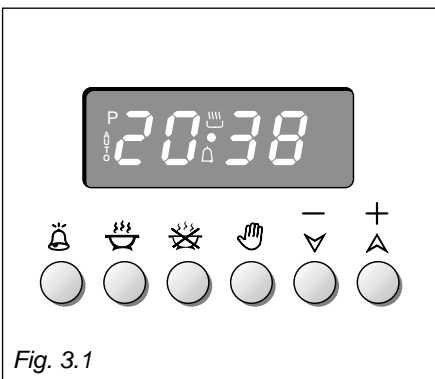

Fig. 3.1

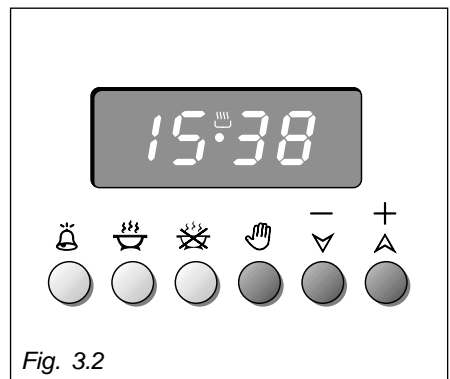









Fig. 3.2

ELECTRONIC CLOCK (fig. 3.2)



The programmer is equipped with an electronic clock with illuminated numbers which indicates hours and minutes. Upon immediate connection of the oven or after a power cut, three zeros will flash on the programmer display.

To set the correct time of day it is necessary to push the  button and then the  (+) or  (-) button until you have set the correct time (fig. 3.2).

In another way push simultaneously the   two buttons and at the same time push the  (+) or  (-) button.

Note: If the clock is reset it deletes any previously set programs

NORMAL COOKING WITHOUT THE USE OF THE PROGRAMMER

To manually use the oven, without the aid of the programmer, it is necessary to cancel the flashing **AUTO** by pushing the button  (**AUTO** will be switched off and the symbol  will illuminate - Fig. 3.3).

Attention: If the **AUTO** is illuminated (which means a cooking program has already been inserted), by pushing the button  you cancel the program and return to manual operation.

If the oven is switch on, you must switch off manually.

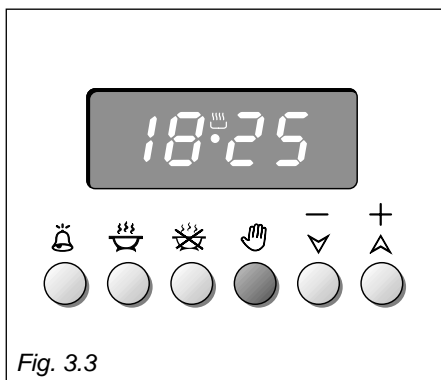







Fig. 3.3



ELECTRONIC TIMER

The timer program consists only of a buzzer which may be set for a maximum period of 23 hours and 59 minutes.

If the **AUTO** symbol is flashing push the  button.

To set the time, push the  button and the  (+) or  (-) until you obtain the desired time in the panel (fig. 3.4). Having finished the setting, the clock hour will appear on the panel and the  symbol will be illuminated.

The countdown will start immediately and may be seen at any moment on the panel by simply pressing the button .

At the end of the time, the  symbol will disappear and the buzzer will sound and continue for approximately 7 minutes or until a button is pressed (not the  (+) /  (-) buttons). After a short time the display will revert back to the time of day.

SETTING THE FREQUENCY OF THE AUDIBLE SIGNAL

The buzzer has 3 different tones and can be changed by pressing the  (-) button, but only when the time of day is displayed

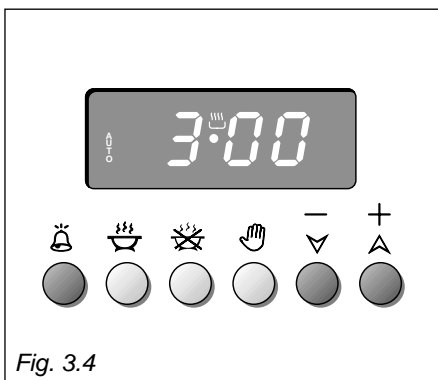









Fig. 3.4

AUTOMATIC OVEN COOKING

To cook food automatically in the oven, it is necessary to:

1. Set the length of the cooking period
2. Set the end of the cooking time
3. Set the temperature and the oven cooking program.

These operations are done in the following way:

1. Set the length of the cooking period by pushing the  button and the  (\oplus) button to increase, or  (\ominus) to decrease if you have passed the desired time (fig. 3.5). The **AUTO** and the  symbol will illuminate.
2. Set the end of the cooking time by pressing the  button (the cooking time already added to the clock time will appear), and the  (\oplus) button (fig. 2.6); if you pass the desired time you may get back by pushing the  (\ominus) button.



After this setting, the  symbol will disappear. If after this setting, the **AUTO** flashes on the display and a buzzer sounds, it means there was an error in the programming, that is that the cooking cycle has been superimposed on the clock. In this case, modify the end of cooking time or the cooking period itself by following again the above mentioned instructions.

3. Set the temperature and the cooking program by using the switch and thermostat knobs of the oven (see specific chapters).

Now the oven is programmed and everything will work automatically, that is the oven will turn on at the right moment to end the cooking at the established hour. During cooking, the  symbol remains illuminated.

By pushing the  button you can see the time that remains until the end of cooking.

The cooking program may be cancelled at any time by pushing .

At the end of the cooking time the oven will turn off automatically, the  symbol will turn off, **AUTO** will flash and a buzzer will be sound, which can be turned off by pushing any of the buttons except the  (\oplus) /  (\ominus) buttons.

Turn the switch and thermostat knobs to zero and put the programmer onto "manual" by pressing the .

Attention: After a power cut the clock resets to zero and cancels the set programs.

After a power cut, three zeros will flash on the display.

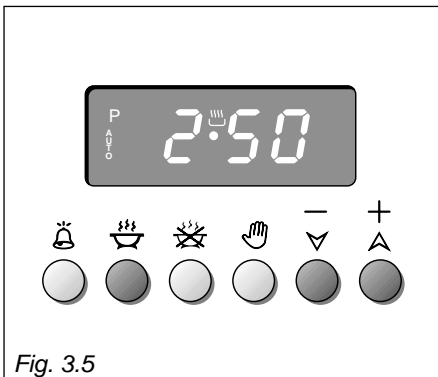

Fig. 3.5

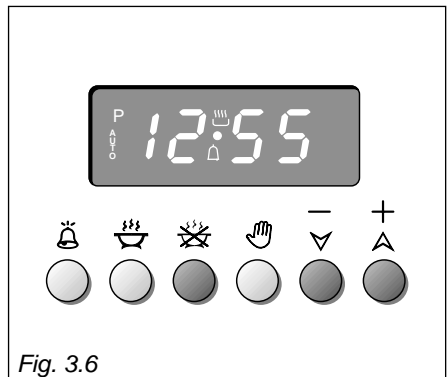





Fig. 3.6

SEMI - AUTOMATIC COOKING



This is used to automatically switch off the oven after the desired cooking period has elapsed.

Set the length of the cooking period by pushing the  button and the  (+) button to increase, or  (-) button to decrease if you have passed the desired time (Fig. 3.7).





AUTO and the  symbol will be illuminated.

Then set the temperature and the cooking program using the function selector switch and thermostat knobs (see specific chapters).

The oven is switched on and it will be switched off automatically at the end of the desired time.

During cooking, the  symbol remains illuminated and by pressing the button  you can see the remaining cooking time..

The cooking program can be cancelled at any time by pushing the  button.

At the end of the cooking period, the oven and the  symbol will disappear, **AUTO** will flash and a buzzer will sound and can be stopped by pushing any of the buttons except the  (+) /  (-) buttons. Turn the function selector switch and thermostat knobs to zero and put the programmer onto "manual" by pressing the  button.

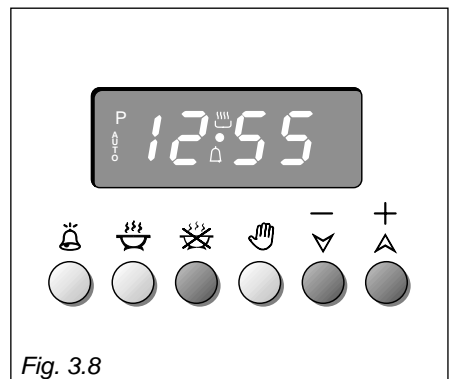
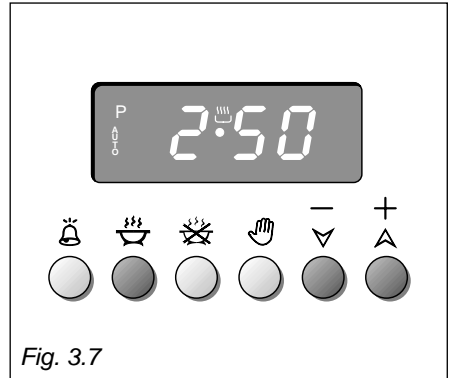



Electronic clock/end cooking timer 4

The electronic programmer is a device with the following functions:

- 24 hours clock with illuminated display
- Timing of oven cooking with automatic switch-off (max. 99 minutes).

ELECTRONIC CLOCK

Upon immediate connection of the oven or after a mains failure, three zeros will flash on the programmer panel.



To set the clock it is necessary to push the  button and then, within 7 seconds, the  or  button until you have set the correct time.

The clock will show zero after a mains failure.

Attention: When the programmer display shows three flashing zeros the oven cannot be switched on.





The oven can be switched on when the symbol  is shown in the display.

SETTING THE FREQUENCY OF THE ALARM SOUND



The selection from 3 possibilities of sound can be made by pressing the  or  button.

COOKING WITH AUTOMATIC SWITCH-OFF

The aim of this function is to automatically stop the cooking after a pre programmed time, for a maximum period of 99 minutes.



To set the cooking time, push the  or  button until you obtain the desired time in the display. The symbol AUTO will be shown in the display. Then you adjust the oven thermostat knob according to the required temperature. The oven will immediately start to operate and will work for the pre programmed time. The display shows the count down. Clock time can be displayed by pressing the  button. Once the time has elapsed, the oven will switch off automatically, the symbol AUTO will go off and an intermittent buzzer, lasting 7 minutes, will start; this can be stopped by pressing the  button.

Important: Before the buzzer is stopped switch off the oven manually.

To cancel the cooking program at any time press the  and  buttons together and release the  button first.

ELECTRONIC ALARM

The programmer can be used as an alarm only for a maximum period of 99 minutes.

To set the alarm, push the  or  button until you obtain the desired time in the display. Once the time has elapsed, an intermittent buzzer, lasting 7 minutes, will start; this can be stopped by pressing the  button.

Attention: If the bottom oven is switched on when the buzzer starts, it will be automatically switched off. For it to operate furtherly you have to stop the buzzer by pressing the  button.

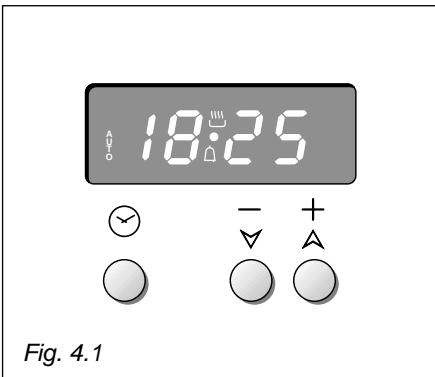





Fig. 4.1

ELECTRONIC CLOCK (fig. 5.1)

The electronic alarm is a device which groups the functions of 24 hours clock with illuminated display and 99 minutes alarm.





Upon immediate connection of the oven or after a blackout, three zeros will flash on the programmer panel.



To set the hour it is necessary to push the  button and then, within 7 seconds, the  or  button until you have set the exact hour.

An energy black-out makes the clock go to zero.

ELECTRONIC ALARM

The alarm program consists only of a buzzer which may be set for a maximum period of 99 minutes.

To set the time, push the  or  until you obtain the desired time in the panel. Having finished the setting, the  symbol will be lighted and the countdown will start immediately. At the end of the time, the  symbol will be switched off and an intermittent buzzer, during 7 minutes, will go off; this can be stopped by pressing the  buttons.

To stop the alarm countdown in any moment press the  and  buttons together and release the  button first.

SETTING THE FREQUENCY OF THE ALARM SOUND

The selection from 3 possibilities of sound can be made by pressing the  button.

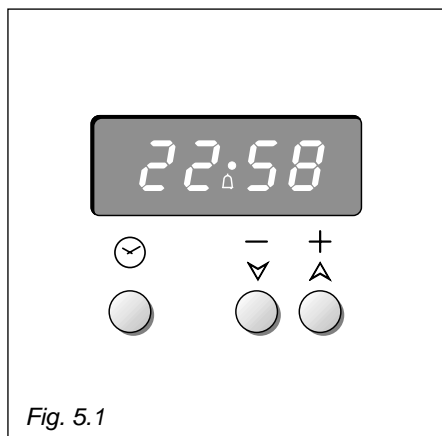

The clock programmer is a device which groups together the following functions:

- Electric clock
- Timing of oven cooking with automatic switch-off (max. 180 minutes).
- End cooking buzzer

SETTING THE TIME

To adjust, simply press the knob "A" (fig. 6.1) and rotate anticlockwise to the correct time.

MANUAL COOKING (without programmer)

To use the oven without the programmer, i.e. only with the function selector/thermostat, the programmer function must be cancelled by rotating knob "A" anticlockwise until the symbol  in window "B" coincides with the indicator (Fig. 6.1).

COOKING WITH AUTOMATIC SWITCH-OFF

- Turn on the oven by setting the switch knob on the desired program and the thermostat knob onto the desired temperature (see specific chapters).
- Set the cooking time by rotating knob "A" anticlockwise until desired time in window "B" coincides with the indicator (Fig. 6.2).

The oven will immediately start to operate and will work for the pre programmed time. Once the time has elapsed, the oven will switch off automatically and an intermittent buzzer will start; this can be stopped by rotating knob "A" until the symbol  in window "B" coincides with the indicator (Fig. 6.3).

Turn the switch and thermostat knobs to "off" position.

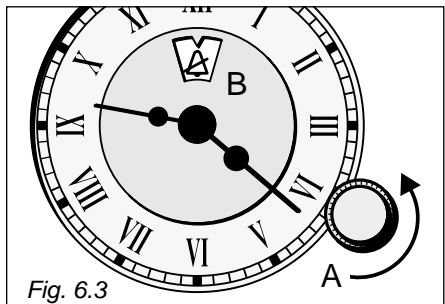
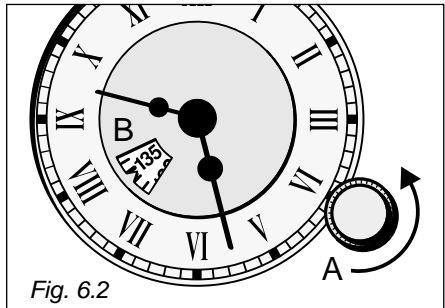
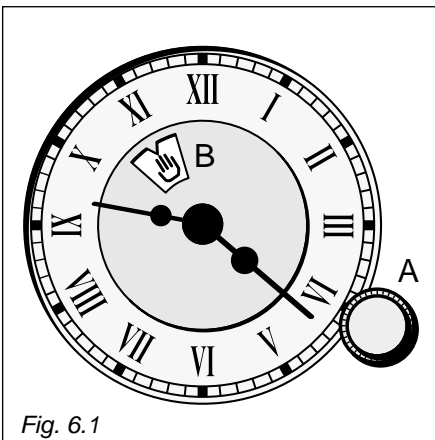

Electric clock with alarm - Electric clock 7

ELECTRIC CLOCK WITH ALARM

(Fig. 7.1)

To adjust the clock, press knob "A" and turn clockwise until it shows the correct time.

Caution: the knob "A" will become loose if turned anticlockwise.

MINUTE COUNTER

The minute counter function consists simply of an acoustic signal which comes on once the set time has elapsed.

To set the minute counter, rotate the small knob (A) clockwise or anticlockwise (without pressing it) until the hand (C) coincides with the required time (max 55 minutes) (Fig. 7.1).

Countdown will begin immediately and the hand (C) will begin to turn anticlockwise, always showing the remaining time.

Once the set time has elapsed the bell will ring until the hand (C) is positioned to the symbol  by rotating the knob (A) anticlockwise.

ELECTRIC CLOCK (Fig. 7.2)

To adjust the clock, press knob "A" and turn clockwise until it shows the correct time.

Caution: the knob "A" will become loose if turned anticlockwise.

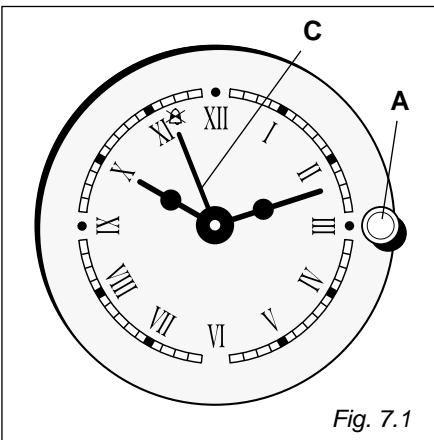

Fig. 7.1

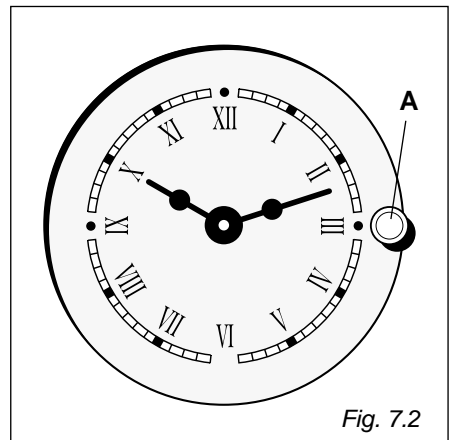

Fig. 7.2

TIMER - 120' CUT-OFF (Fig. 8.1)

The function of the timer runs the oven for a preset time.

1) Starting up.

After setting the function selector and thermostat to the required mode and temperature, rotate the timer knob clockwise until you reach the required cooking time (max 120 minutes).

Once this time has elapsed, the timer will return to the "0" position and the oven will automatically switch off.

2) Manual position.

If the cooking time is longer than two hours or if you wish to use the oven manually, switching it off as required, the knob must be turned to position .

60' ALARM (Fig. 8.2)

The minute counter is a timed acoustic warning device which can be set for a maximum of 60 minutes.

The knob must be rotated clockwise as far as the 60 minute position and then set to the required time by rotating it anti-clockwise.

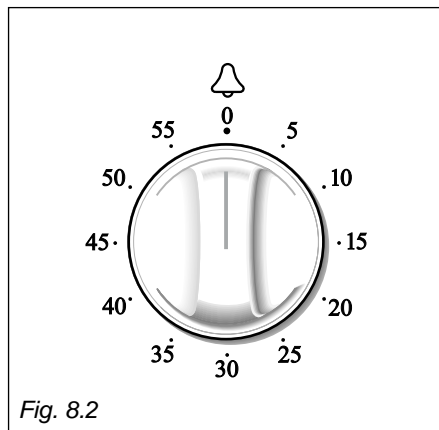
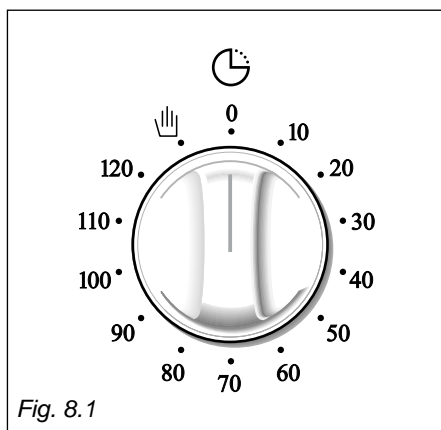

GENERAL ADVICE

Important:

Before any operation of cleaning and maintenance disconnect the appliance from the electrical supply.

It is advisable to clean when the appliance is cold and especially for cleaning the enamelled parts.

Avoid leaving alkaline or acidic substances (lemon juice, vinegar, etc.) on the surfaces.

Avoid using cleaning products with a chlorine or acidic base.

The oven must always be cleaned after every use, using suitable products and keeping in mind that its operation for 30 minutes on the highest temperature eliminates most grime reducing it to ashes.

STAINLESS STEEL SURFACES WITH ANTI-FINGERPRINT TREATMENT

CAUTION:

The stainless steel front surfaces used in some ovens are protected with a Special Lacquer to reduce finger-print marks.

To avoid damaging this lacquer, do not clean the stainless steel with abrasive cleaners or abrasive cloths or scouring pads.

ONLY SOAP/WARM WATER MUST BE USED TO CLEAN THE STAINLESS STEEL SURFACES.

STAINLESS STEEL AND ALUMINIUM PARTS AND SILK-SCREEN PRINTED SURFACES

Clean using an appropriate product. Always dry thoroughly.

IMPORTANT: these parts must be cleaned very carefully to avoid scratching and abrasion. You are advised to use a soft cloth and neutral soap.

ENAMELLED PARTS

All the enamelled parts must be cleaned with a sponge and soapy water only or other non-abrasive products.

Dry preferably with a chamois leather.

INSIDE OF OVEN

The oven must be always cleaned after every use, using suitable products and keeping in mind that its operation for 30 minutes on the highest temperature eliminates most grime reducing it to ashes.

Do not use a steam cleaner because the moisture can get into the appliance thus make it unsafe.

Do not store flammable material in the oven.

OVEN FITTING OUT

Models with embossed cavity

The oven shelves are provided with a security block to prevent accidental extraction.

They must be inserted operating as per figure 9.1.

To pull them out operate in the inverse order.

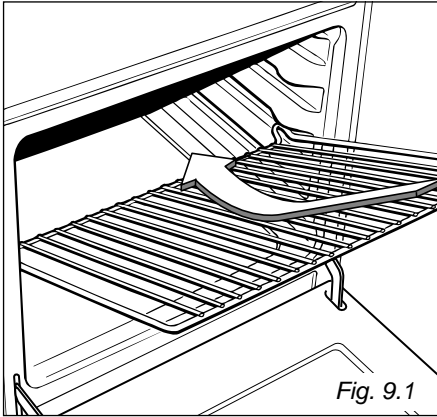

Models with wire racks

- Assemble the wire racks to the oven walls using the 2 screws (fig. 9.2).
 - In the models with catalytic panels interpose the catalytic panels "A" with the arrow up (fig. 9.2).
 - Slide in, on the guides, the shelf and the tray (fig. 9.3).
- The shelf must be fitted so that the safety catch, which stops it sliding out, faces the inside of the oven.
- To dismantle, operate in reverse order.

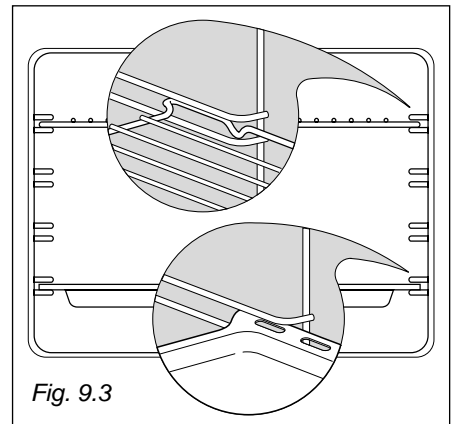
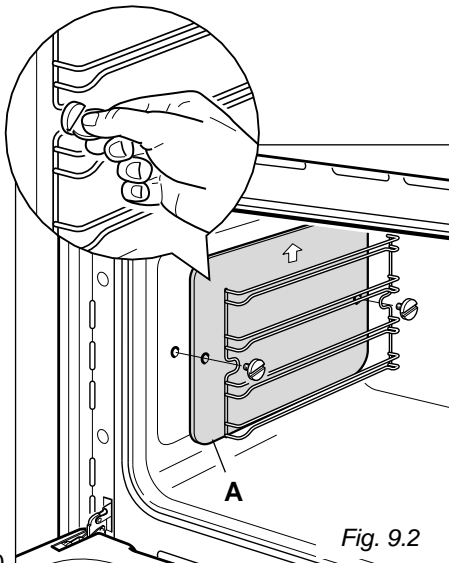

Models with tilting grill and wire racks

- Assemble the wire racks on the oven walls using the 2 screws (fig. 9.4).
- In the models with catalytic panels interpose the catalytic panels "A" with the arrow up (fig. 9.4).
- Slide in, on the guides, the shelf and the tray (fig. 9.3).

The rack must be fitted so that the safety catch, which stops it sliding out, faces the inside of the oven.

To dismantle, operate as follows:

- Unscrewing the fixing screws and slide off the wire racks and the catalytic liners (if supplied) to the oven wall as in fig. 9.4.

The grill is secured to the rear wall of the oven on a hinge system that allows it to be lowered to allow proper access when cleaning the oven ceiling (fig. 9.5).

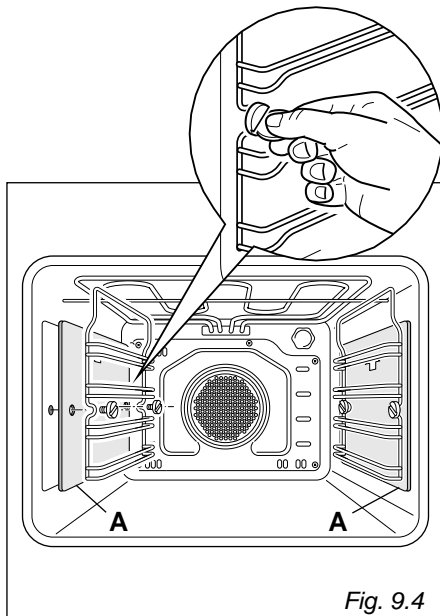

Models with tilting grill and sliding shelves

- Assemble the sliding shelves on the oven walls using the 2 screws (fig. 9.6).
- In the models with catalytic panels interpose the catalytic panels "A" with the arrow up (fig. 9.6).
- Position the shelf and tray on the sliding shelves (fig. 9.7).

To dismantle, operate as follows:

- Unscrewing the fixing screws and slide off the sliding shelves and the catalytic liners (if supplied) to the oven wall as in fig. 9.6.

The grill is secured to the rear wall of the oven on a hinge system that allows it to be lowered to allow proper access when cleaning the oven ceiling (fig. 9.5).

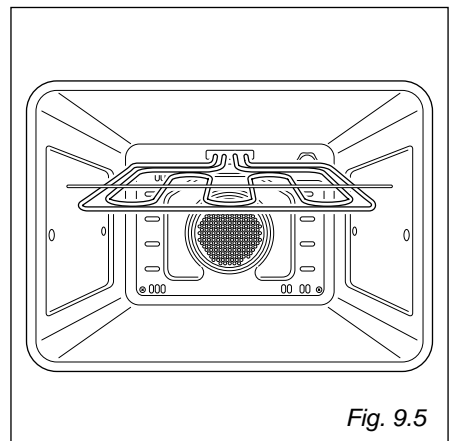

SLIDING SHELVES (some models only)

- The sliding shelves facilitate the insertion and removal of shelves during cooking. These shelves support all accessory trays and are dishwasher safe.
- The shelves stop when pulled out to the maximum position.
- The sliding shelves can be removed easily by unscrewing the fixing screws and detaching them from the oven walls.
- Removing the sliding shelves improves access to the oven ceiling for cleaning (after the grill heating element has been lowered - fig. 9.5).

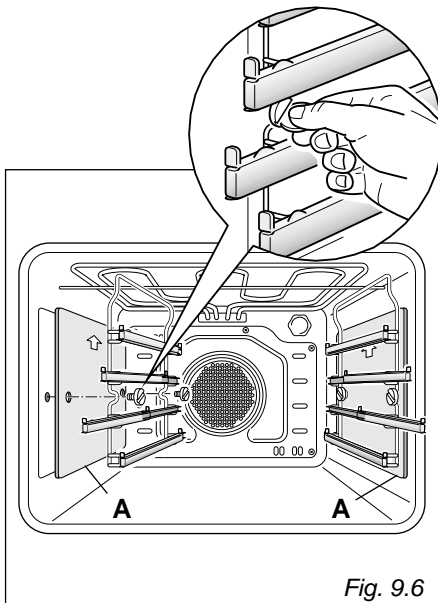

Fig. 9.6

ADVICE FOR USE AND MAINTENANCE OF CATALYTIC PANELS (some models only)

The catalytic panels are covered with special microporous enamel which absorbs and does away with oil and fat splashes during normal baking over 200°C.

If, after cooking very fatty foods, the panels remain dirty, operate the oven "idling" on max temperature for about 30 minutes.

These panels do not require to be cleaned, however it is advised to periodically remove them from the oven (at least the side panels) and to wash them with tepid soapy water and then wipe off with a soft cloth.

DO NOT CLEAN OR WASH THEM WITH ABRASIVE PRODUCTS OR WITH PRODUCTS CONTAINING ACIDS OR ALKALIS.

The side panels are reversible and when the catalytic microporous enamel degrades, they can be turned to the other side.

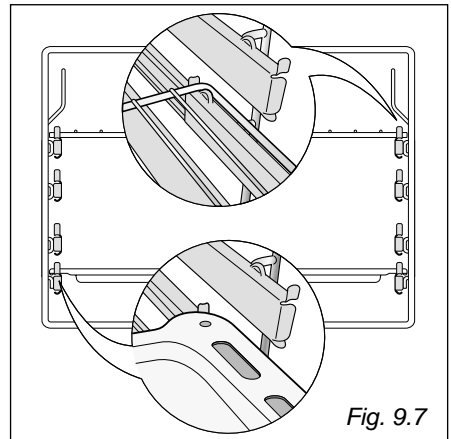

Fig. 9.7

REPLACING THE OVEN LIGHT

Before any maintenance is started involving electrical parts of the appliance, it must be disconnected from the power supply.

- Let the oven cavity and the heating elements cool down;
- Switch off the electrical supply;
- Unscrew the protective cover (fig. 9.8);
- Unscrew and replace the bulb with a new one suitable for high temperatures (300°C) having the following specifications: 230-240V 50 Hz, 15W, E14;
- Refit the protective cover;

NOTE: Oven bulb replacement is not covered by your guarantee.

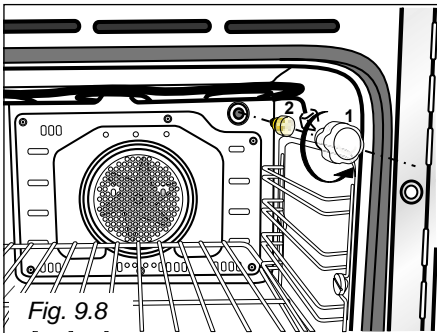

REMOVING THE OVEN DOOR

The oven door can easily be removed as follows:

- Open the door to the full extent (fig. 9.9a).
- Open the lever “A” completely on the left and right hinges (fig. 9.9b).
- Hold the door as shown in fig. 9.9.
- Gently close the door (fig. 9.9) until left and right hinge levers “A” are hooked to part “B” of the door (fig. 9.9b).
- Withdraw the hinge hooks from their location following arrow “C” (fig. 9.9d).
- Rest the door on a soft surface.
- To replace the door, repeat the above steps in reverse order.

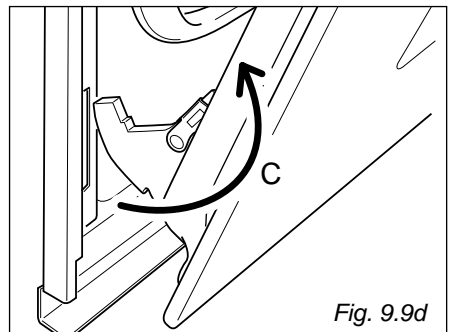
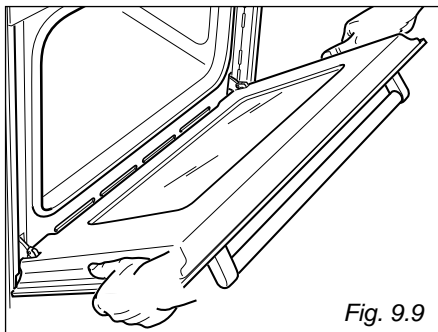
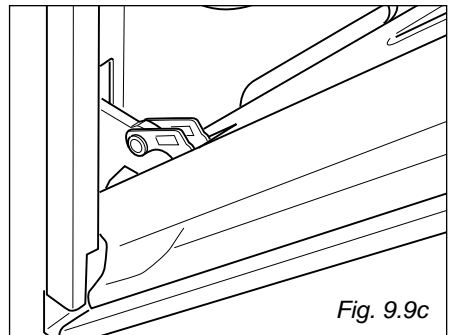
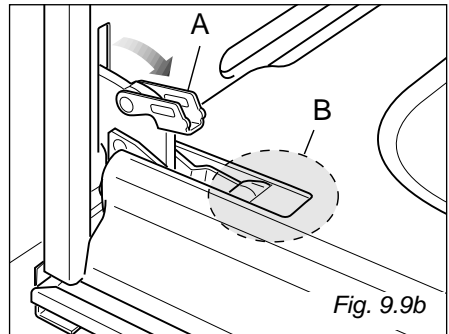
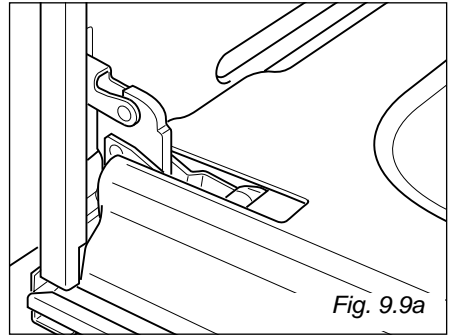

Advice for the installer



IMPORTANT

- The appliance should be installed by a **QUALIFIED INSTALLATION TECHNICIAN**. The appliance must be installed in compliance with regulations in force.

The oven can be fitted in standard units, width and depth 60 cm. Installation requires a compartment as illustrated in figures 10.1 and 10.2. On the lower side, the oven must lay on supports standing the oven weight. The 4 screws serve as fixing.

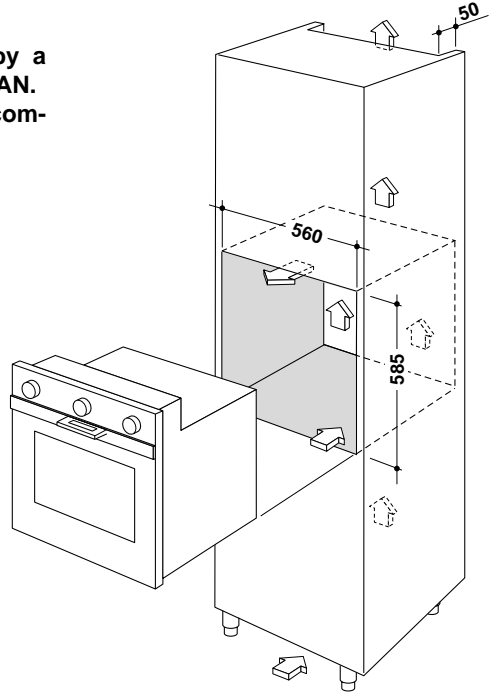

Fig. 10.1

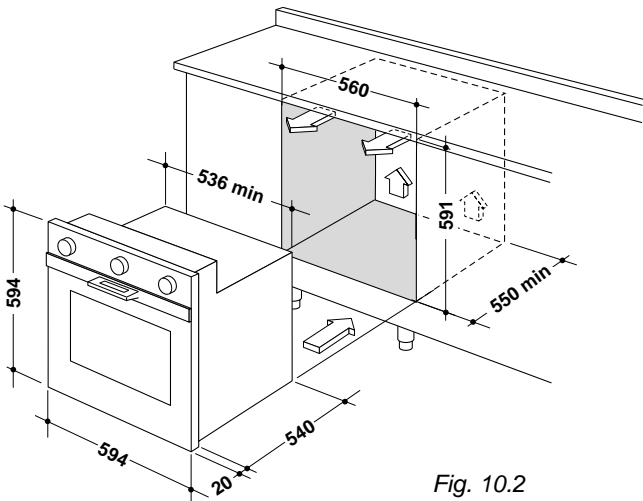

Fig. 10.2

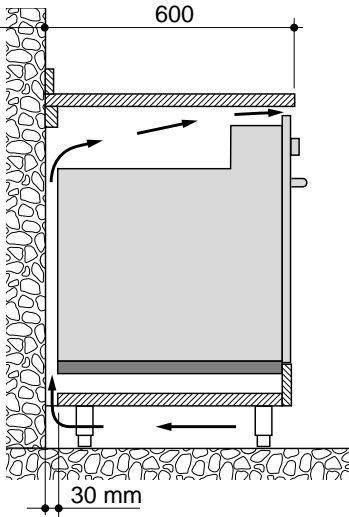

Fig. 10.3

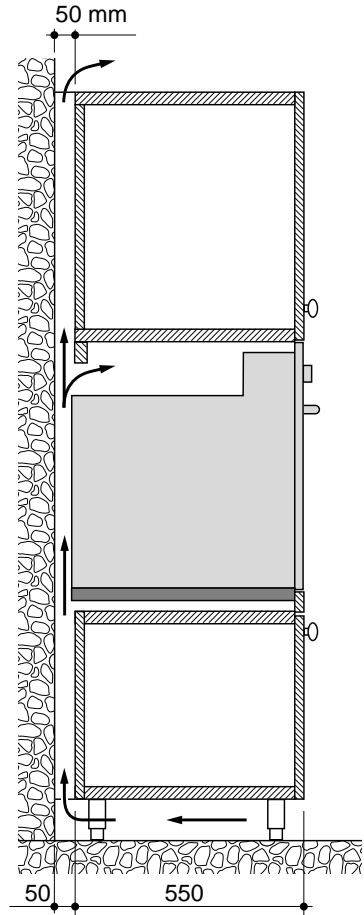

Fig. 10.4

To ensure internal ventilation, aeration channels must be provided as illustrated in the figures 10.3 and 10.4.

**The walls surrounding the oven must be made of heat-resistant material.
Taking care NOT to lift the oven by the door handle.**

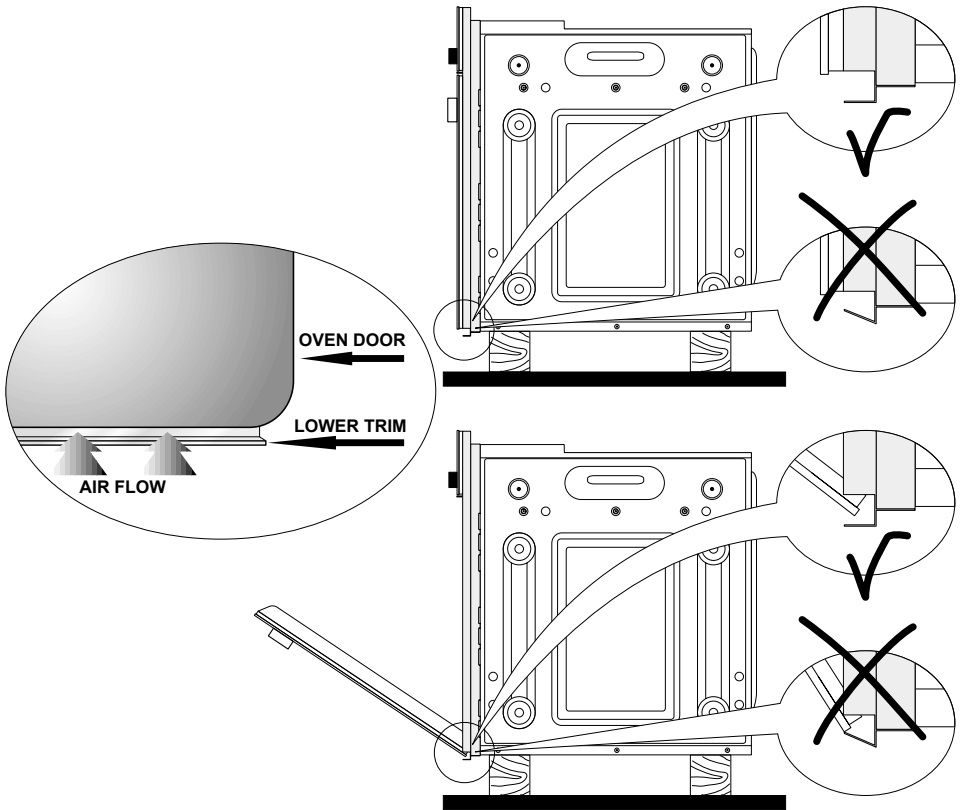

Fig. 10.5

IMPORTANT:

To avoid damage to the lower trim please note the following instructions.

The lower trim is designed to allow for good air circulation and the correct opening of the oven door.

To ensure the trim is not damaged due to the appliance being placed on the floor, the appliance should be suitably supported as in above illustrations.

After installation the appliance door should be slowly opened to ensure no damage has occurred.

No responsibility for lower trim damage will be accepted if these instructions have not been followed.

Before effecting any intervention on the electrical parts the appliance must be disconnected from the network.

GENERAL

- The connection to the electrical network must be carried out by qualified personnel and must be according to existing norms.
- The appliance must be connected to the electrical network verifying above all that the voltage corresponds to the value indicated on the specifications plate and that the cables section of the electrical plant can bear the load which is also indicated on the plate.
- If the appliance is supplied without a power supply plug and if you are not connecting directly to the mains, a standardized plug suitable for the load must be fitted.
- The colours of the wires in the appliance power cable may not correspond with the colours marked on the terminals of your electrical plug. The plug should always be wired as follows:
 - connect the green/yellow wire to the terminal marked with the letter E or the earth symbol or coloured green/yellow;
 - connect the blue wire to the terminal marked with the letter N or coloured black;
 - connect the brown wire to the terminal marked with the letter L or coloured red.

- The bi-polar plug must be connected to an outlet connected to the grounding unit in conformity to security norms.
- If the oven is to be connected directly to the mains, it must be placed with an omnipolar switch with minimum opening between the contacts of 3 mm between the appliance and the mains.
- The power supply cable must not touch the hot parts and must be positioned so that it does not exceed 75°C at any point.
- Once the oven has been installed, the switch or socket must always be accessible.
- If the power supply cable is damaged it must be substituted by a suitable cable available in the after sales service.

N.B. For connection to the mains, do not use adapters, reducers or branching devices as they can cause overheating and burning.

If the installation requires alterations to the domestic electrical system call an expert.

He should also check that the socket cable section is suitable for the power absorbed by the appliance.

The connection of the appliance to the grounding unit is mandatory. The manufacturer declines every responsibility for any inconvenience resulting from the inobservance of this condition.

CONNECTION OF THE POWER SUPPLY CABLE

Unhook the terminal board cover by inserting a screwdriver into the two hooks "A" (fig. 11.1).

Open the cable gland by unscrewing screw "F" (fig. 11.2), unscrew the terminal screws and remove the cable.

The new supply cable, of suitable type and section, is connected to the terminal board following the diagram fig. 11.3.

FEEDER CABLE SECTION TYPE HO5RR-F

230 V ~ 3 x 1,5 mm²

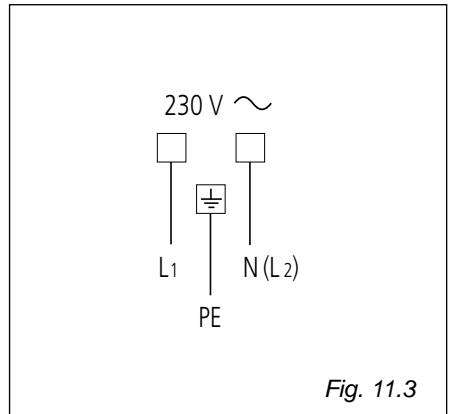
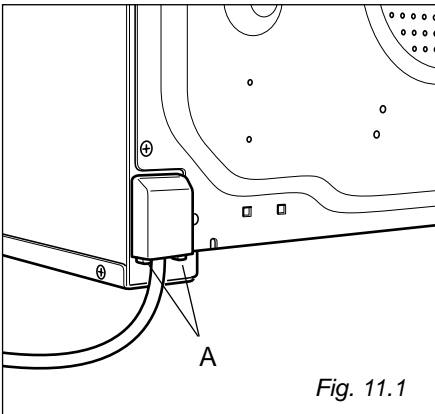
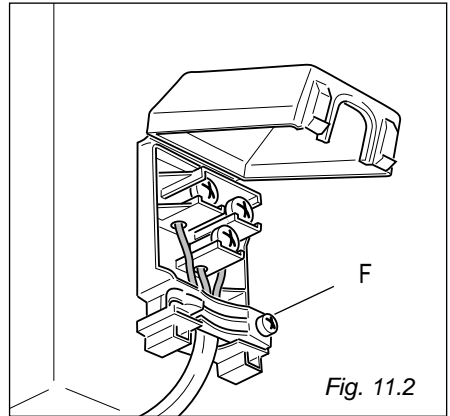



Descriptions and illustrations in this booklet are given as simply indicative.
The manufacturer reserves the right, considering the characteristics of the models described here, at any time and without notice, to make eventual necessary modifications for their construction or for commercial needs.